

EXCLUSIVE

Industry's Unique Features

- ◇ Flip**Drive** Transformable Ride System
- ◇ Foldable Chassis
- ◇ XXL Front Wheel Extra Stability
- ◇ Increased Visibility Design
- ◇ One Hand Motion Motorcycle Type
- ◇ Easy Gun Selector
- ◇ Vibrated Assisted Bead Hopper 21 lt
- ◇ T.C.S - Tunnel Cooling System
- ◇ Disk Lock Hand Brake



ProStripe 200 Version	Working Pressure	Engine Power	Max Flow	Paint Gun
Basic	240 bar / 3500psi	4.8 hp / 5.5 hp	6.5 l/min	1 / 2
Standard	240 bar / 3500psi	4.8 hp / 5.5 hp	6.5 l/min	1 / 2



ProStripe 300 Version	Working Pressure	Engine Power	Max Flow	Paint Gun / Automatic
Standard	240 bar / 3500psi	5.8 hp / 6.5 hp	8.5 l/min	1 / 2
Self Propelled	240 bar / 3500psi	8.4 hp / 9.0 hp	8.5 l/min	1 / 2
Automatic i	240 bar / 3500psi	5.8 hp / 6.5 hp	8.5 l/min	1 / 2 Auto
Self Propelled Auto	240 bar / 3500psi	8.4 hp / 9.0 hp	8.5 l/min	1 / 2 Auto



ProStripe 400 Versions	Working Pressure	Engine Power	Max Flow	Paint Gun / Automatic
Self Propelled	240 bar / 3500psi	11.7 hp / 13 hp	12.0 l/min	1 / 2
Self Propelled Auto	240 bar / 3500psi	11.7 hp / 13 hp	12.0 l/min	1 / 2 Auto
Self Propelled Twin	240 bar / 3500psi	11.7 hp / 13 hp	12.0 l/min	2 / 3 Auto



Full Console:

Easy Gun Selector

Data Display

Pressure Adjustment

Kill Switch

Speed Selector

Engine Throttle

Hand Break

Cup Holder

Motorcycle

Motion Control

Foldable Chassis

Adjustable Handle

Glass Bead Hopper 21 lit
Vibrated Assisted System

Paint Hopper 68 lit

T.C.S System

Honda Engine

Easy Top Sided
Alignment

XXL Front Wheel

3 Gun Operation

1 or 2 hydraulic
pumps

Durable 6 Ply Tires

**Disk Lock
Brake System**

Light Kit

Revolutionary double drive
method, **sit/stand FlipDrive**
with hidden storage
compartment & extra space
for paint or gas tank

On The Go Pattern Selection - Easy Gun Selector

Simple gun pattern selection, directly from the main console. No need to stop working and change wiring. With the VEZOS E.G.S. pattern selection while on the go simply adjust the gun pattern to support single, double & skip lines.



EXCLUSIVE



Hand Brake System

Easy hand brake secure system, apply brake from console to activate the disk



Holder - Cup or Storage Space

Clever thinking!!! This extra holder on the ProStripe console, has been designed especially for you. On the job and don't have time for a coffee break? No need to worry, enjoy a hot cup of coffee while striping. Use the holder also for storing extra gun tips or anything else needed on the job.



EXCLUSIVE



Gun Pressure Adjustment Control

Easy gun pressure adjustment from the main console, for desired result.

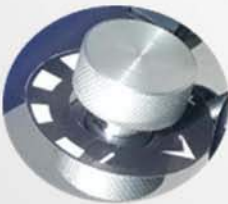

Honda Engine Throttle

Adjust the Honda engine revs according to the jobs demands.



Kill Switch

Console operated kill switch for turning off the Honda engine.

Motorcycle Type Motion Control System

VEZOS Motorcycle type motion control, is an easy to control driving system installed on the ProStripe Hydraulic Self-Propelled units. As simple as driving a motorcycle, with no complex pedals, buttons or extra levers. This one handed motion control, has a common left-right movement system allowing the SP unit to work with or without the FlipDrive seat, especially when tackling uphill roads with a heavy loaded unit.

EXCLUSIVE



ProStripe 300 & 400 editions, are equipped with an easy to work digital monitor, offering on the job data and life time proof of the units run times.

Set the digital display to your required measurements , adjust the line widths, monitor the engines performance, measure job distance & material consumption.

VEZOS Digital Monitor Display is located in the middle of the units console, easy to follow when walking behind the unit or even when riding the FlipDrive in standing or sitting position.

Job Panel - Digital Monitor Display

11:30 am	Timer 03:45	- Job Panel -		SEL
Speed	5.4	Km/h		↑
Pressure	180	Bar		↓
Film build inst.	620	Mic		

11:30 am	Timer 03:45	- Job Panel -		SEL
Film build job	633	Mic		↑
Spray dist. job	2.25	Km		↓
Material job	171.5	Lit		

Data Panel - Digital Monitor Display

11:30 am	Timer 03:45	- Data Panel -		SEL
Spray dist. life	235	Km		↑
Travel life	272	Km		↓
Material life	18075	Lit		

11:30 am	Timer 03:45	- Data Panel		SEL
Material life total	19234	Km		↑
Engine hrs life	128	Hrs		↓
Engine rpm	3100	rpm		

Setting Panel - Digital Monitor Display

11:30 am	Timer 03:45	- Set. Panel		SEL
Measure	0.824	Km		↑
Line Width	12	cm		↓
Calibration	000			

11:30 am	Timer 03:45	- Set. Panel		SEL
Reset job data	----			↑
Change units	0000			↓
Gun spray sensor	000			

Pallet Concept

VEZOS Unique Features

VEZOS designs are cost saving on the job, but before the units arrive to their final destination - you the end-user - they are transported worldwide. Now you may think that this fact does not interest or concern you, well this is where the whole misconception is... The more space a product takes up, the higher the transport cost, therefore increase in your purchasing price! This is a fact that VEZOS takes very seriously and hopes to achieve the best value/product equation possible. How? By thinking out of the box, by smart innovative solutions.

VEZOS ProStripe range all fit on a single standard European pallet 120cm x 80cm!

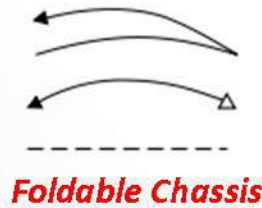
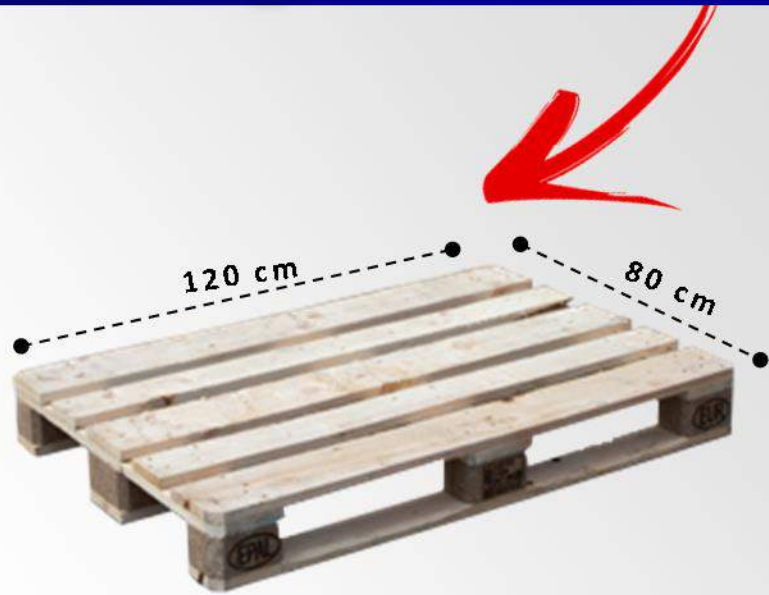

Foldable Chassis



Fits in city van

VEZOS Unique Features

And of course it doesn't end here, ok transport is a major factor and has saved cost, but what happens when you need to fit the unit through a doorway, at the end of the job when you need to store your ProStripe unit and most importantly when you need to take the unit to the job site?

VEZOS has thought all this out! **IT FITS EVERYWHERE** Pass with ease the ProStripe through any standard doorway, store it in your business, garage or warehouse without taking up the entire space and finally fit the ProStripe in any small city van or even Station Wagon that you may own, without having to bring it to parts, due to its foldable design.





Hydraulic Slow Stroke Pump



Quality Test Pass

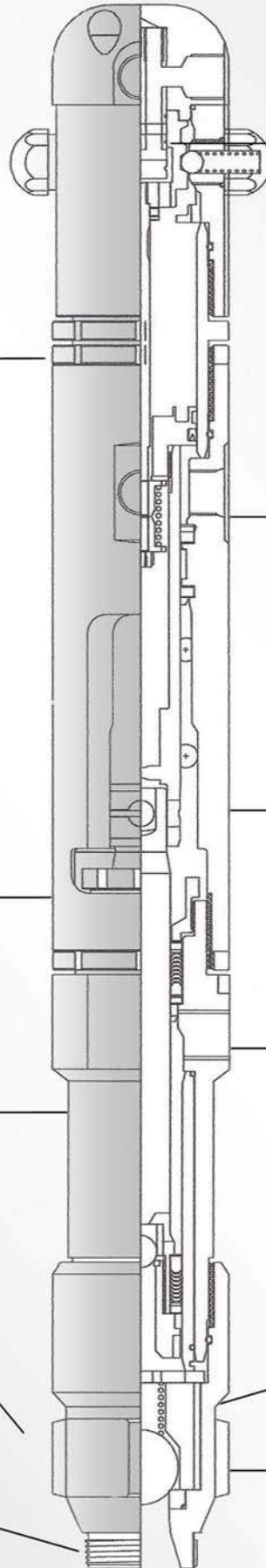

Long sized slow stroke pump
(improved durability)

Hydraulic valve designed with oversized passages for improved flow
(improved durability)

Hard chromed hydraulic rod
(improved durability)

Easy release pump connection for on the spot service
(improved handling)

SST cylinder (improved durability)

Adjustable packing nut
(improved handling)

Hard chromed pump rod
(improved durability)

Spring loaded Inlet valve for quick closing even with heavy materials

No tools release inlet valve
(improved handling)

Extreme size 1 1/4" inlet valve for best handling with heavy materials
(improved performance)

Quick connection for inlet attachments
(improved handling)





Quality Test Pass

Quality Test

VEZOS High Standard Test

VEZOS guarantees that every single pump that leave the production line, undertakes a high standard 30 min quality test, in full power and pressure, ensuring correct function of the equipment.

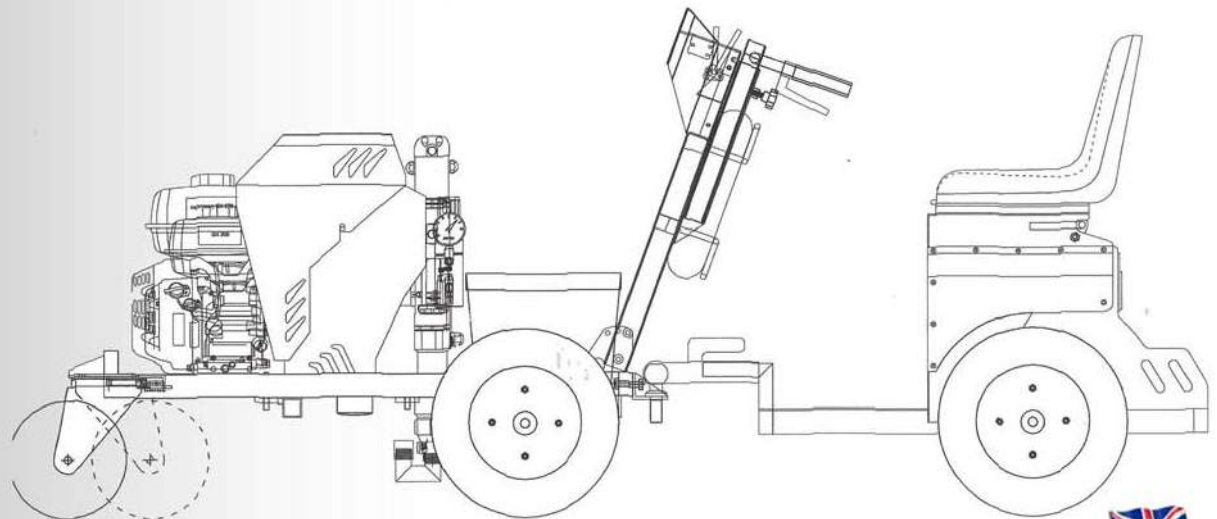
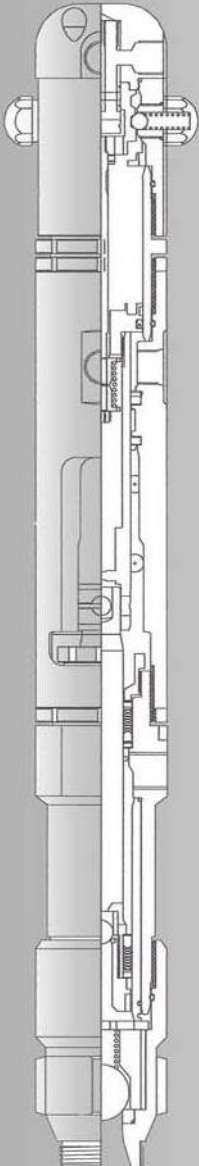

Warranty 3+3

VEZOS 6 Year Plan

VEZOS offers a reliable warranty for each hydraulic airless striper, ensuring users that they are covered by the VEZOS manufacturers warranty.

Now VEZOS is the first airless manufacturer to offer a **6 year warranty plan**, simply register your unit after the purchase and VEZOS will take care of the rest.

WARRANTY

3+3=6

VEZOS WARRANTY PLAN
 Register your pump for a free 3 year coverage
www.vezos.co.uk





Flip Drive

Double Ride Option

“ Transform Concept ”



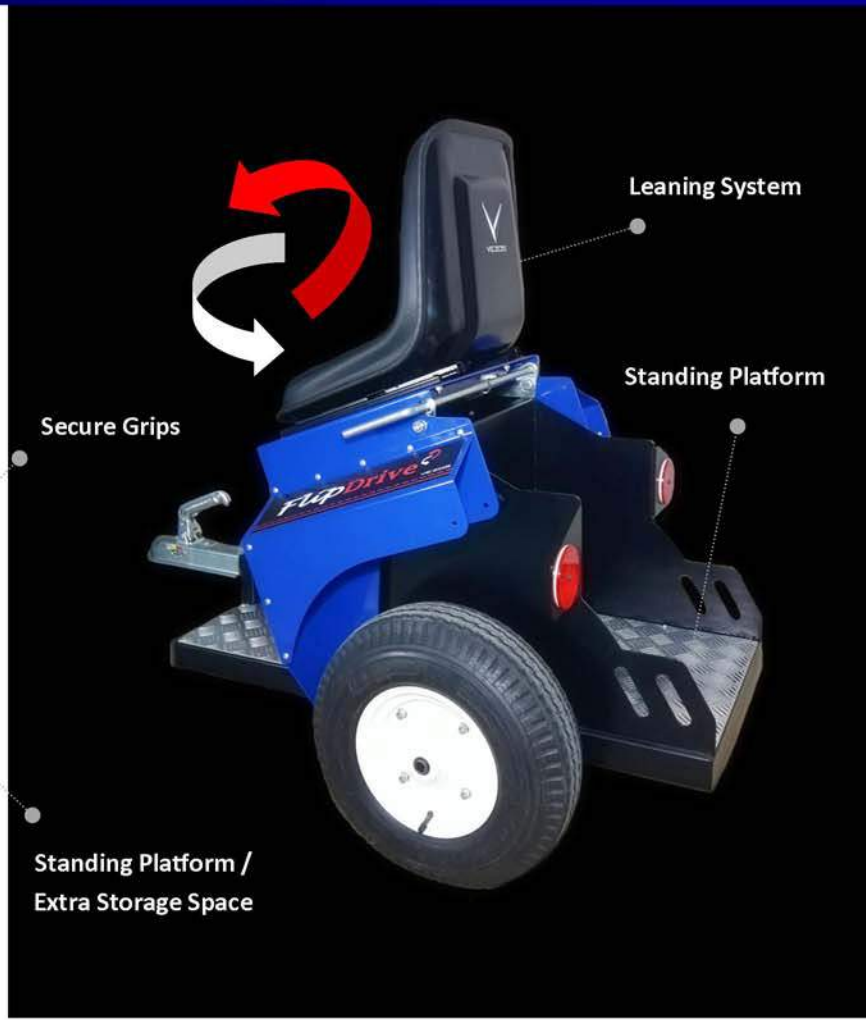

FlipDrive, Double ride Option - "Transform Concept"

Connect the FlipDrive to all Self-Propelled VEZOS ProStripe models, on the spot - no tool, flip system for overall visibility on the job. Hidden non-slip storage space for tools. Extra storage space for warning cones, gas or paint tank. No complex pedals for steering the FlipDrive, simply use the ProStripe steering handles.

Enjoy the ride !!!





Unmatched Visibility

VEZOS Unique Features

Carefully designed, the ProStripe Self-Propelled striper with FlipDrive Seat, increases visibility even when striping with the bead hopper attached.

Choose between a sitting or standing position increasing the visibility of the road.

VEZOS ProStripe offers a panoramic view of the road & eliminates the blind areas, *even in sitting position with the bead hopper on !*

FlipDrive, Double ride Option

“ Transform Concept ”



ProStripe with bead hopper shown

FlipDrive

Ride *sitting*

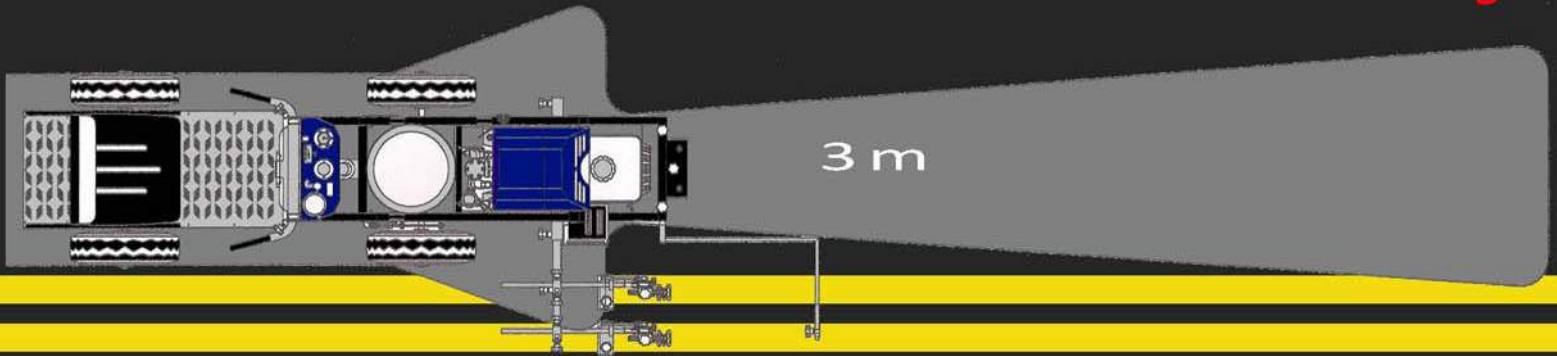

ProStripe with bead hopper shown

FlipDrive

Ride *standing*

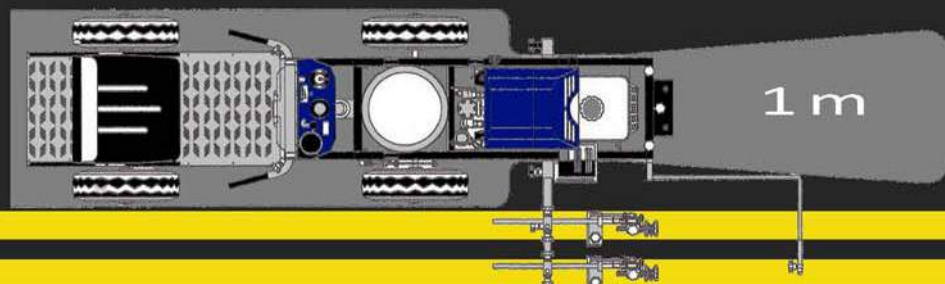



⇒ ProStripe 200 Walk Behind

- Introduction
- Editions & Technical Characteristics



⇒ ProStripe 300 Walk Behind / Self-Propelled / Automatic

- Introduction
- Editions & Technical Characteristics



⇒ ProStripe 400 Self-Propelled / Automatic

- Introduction
- Editions & Technical Characteristics

ProStripe 200

Walk Behind Hydraulic Line Striper



ProStripe p/n 23.9007102

ProStripe 200 Series

Hydraulic Line Striper

1 or 2 gun performance hydraulic striper, equipped with VEZOS T.C.S. technology is contractors first choice for line marking small & medium jobs. The ProStripe 200 foldable chassis & motorcycle type control, along with multiple VEZOS unique innovations embedded to this unit, offer the industry a revolutionary opportunity in striping.

Custom Fit Paint Hopper

60 liter hopper



Features & Highlights

Unique VEZOS Features

- ◆ Foldable Chassis
- ◆ XXL wheel for extra stability
- ◆ Easy Wheel Alignment
- ◆ Motorcycle Type Control / One hand motion system
- ◆ TCS - Tunnel Cooling System
- ◆ Disk lock hand brake
- ◆ Easy angle front wheel selector
- ◆ 6 ply industrial tires for long life durability
- ◆ Spring assisted gun holder
- ◆ Slow Stroke Hard Chromed Hydraulic Pump
- ◆ Anti-vibration system
- ◆ Low centered gravity design
- ◆ Rear gun mount system

EXCLUSIVE

Applications

ProStripe 200 Hydraulic

- ◆ City Roads
- ◆ Parking Lots
- ◆ Intersections
- ◆ Schools / Playgrounds
- ◆ Bike Lanes
- ◆ Sport Fields

Materials

ProStripe 200 Hydraulic

- ◆ Common Road Marking Paint
- ◆ Heavy VOC paint
- ◆ Waterborne Paint
- ◆ Rubberized Marking Paint



ProStripe p/n 23.9007102



Editions

ProStripe 200 Hydraulic

Product Number	23.9007100	23.9007102
ProStripe Edition	PS 200 1G	PS 200 2G
ProStripe Category	Standard	Standard
Max Working Pressure	240 bar	240 bar
Max Flow	6.5 l/min	6.5 l/min
Motor Power Honda	4.8 hp net *	4.8 hp net *
* in accordance SAE J1349	5.5 gross	5.5 gross
Paint Gun - 1	1 piece	1 piece
Paint Gun - 2	Optional	1 piece
Foldable Handle	Included	Included
Pointer 55cm	Accessory	Accessory
Bead Dispenser	Accessory	Accessory
Paint Hopper	68 lt - 18gpm	68 lt - 18gpm



ProStripe 300

Walk Behind or Self Propelled Hydraulic Line Striper



ProStripe p/n 23.9008112 + FlipDrive + Paint Hopper



EXCLUSIVE

ProStripe 300 Series

Hydraulic Line Striper

Road marking industry's first double ride striper, FlipDrive by VEZOS, completes this powerful hydraulic line striper. Experience the jobs panoramic view with this increased visibility system while standing, even when working with the glass bead hopper attached. ProStripe 300 has an outstanding 8.5 l/min flow rate, powered by a Honda engine & VEZOS slow stroke hard chromed hydraulic pump equipped with it unique T.C.S. Tunnel Cooling System technology.

Features & Highlights

Unique VEZOS Features

- ◆ Foldable Chassis
- ◆ FlipDrive transformable ride system
- ◆ XXL wheel for extra stability
- ◆ Vibrated assisted bead hopper 21 lit
- ◆ Easy Wheel Alignment
- ◆ Increased visibility design
- ◆ Easy gun selector - E.G.S.
- ◆ Motorcycle Type Control / One hand motion system
- ◆ TCS - Tunnel Cooling System
- ◆ Disk lock hand brake
- ◆ Easy angle front wheel selector
- ◆ 6 ply industrial tires for long life durability





Rear Gun & Bead Hopper

ProStripe 300 Hydraulic

Simple, no tools required, turn the hopper around and place the guns on the rear end of the striper for stable long lines.

Applications

ProStripe 300 Hydraulic

- ◆ City Roads
- ◆ Airports
- ◆ Parking Lots
- ◆ Intersections
- ◆ Schools / Playgrounds
- ◆ Bike Lanes

Materials

ProStripe 300 Hydraulic

- ◆ Common Road Marking Paint
- ◆ Heavy VOC paint
- ◆ Waterborne Paint
- ◆ Rubberized Marking Paint

Features & Highlights

Extra Features

- ◆ Spring assisted gun holder
- ◆ Slow Stroke Hard Chromed Hydraulic Pump
- ◆ Anti-vibration system
- ◆ Low centered gravity design
- ◆ Light Kit
- ◆ Rear gun mount system



ProStripe p/n 23.9008102

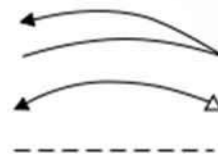

Foldable Chassis

EXCLUSIVE



ProStripe p/n 23.9008102



Product Number	23.9008100	23.9008102	23.9008110	23.9008112
ProStripe Edition	PS 300 1G	PS 300 2G	PS 300 SP 1G	PS 300 SP 2G
ProStripe Category	Standard	Standard	Self-Propelled	Self-Propelled
Max Working Pressure	240 bar	240 bar	240 bar	240 bar
Max Flow	8.5 l/min	8.5 l/min	8.5 l/min	8.5 l/min
Motor Power Honda * in accordance SAE J1349	5.8 hp net * 6.5 gross	5.8 hp net * 6.5 gross	8.4 hp net * 9.0 gross	8.4 hp net * 9.0 gross
Paint Gun - 1	1 piece	1 piece	1 piece	1 piece
Paint Gun - 2	Optional	1 piece	Optional	1 piece
Adjustable Handle	Included	Included	Included	Included
Pointer 55cm	Accessory	Accessory	Accessory	Accessory
Bead Dispenser	Accessory	Accessory	Accessory	Accessory
Paint Hopper	68 lt - 18gpm	68 lt - 18gpm	68 lt - 18gpm	68 lt - 18gpm
FlipDrive Seat	n/a	n/a	Accessory	Accessory
Product Number	23.9008120	23.9008122	23.9008130	23.9008132
ProStripe Edition	PS 300 Auto1G	PS 300 Auto 2G	PS 300 SP Auto 1G	PS 300 SP Auto 2G
ProStripe Category	Automatic i	Automatic i	Auto i Self-Propelled	Auto i Self-Propelled
Max Working Pressure	240 bar	240 bar	240 bar	240 bar
Max Flow	8.5 l/min	8.5 l/min	8.5 l/min	8.5 l/min
Motor Power Honda * in accordance SAE J1349	5.8 hp net * 6.5 gross	5.8 hp net * 6.5 gross	8.4 hp net * 9.0 gross	8.4 hp net * 9.0 gross
Auto Paint Gun - 1	1 piece	1 piece	1 piece	1 piece
Auto Paint Gun - 2	Optional	1 piece	Optional	1 piece
Adjustable Handle	Included	Included	Included	Included
Pointer 55cm	Accessory	Accessory	Accessory	Accessory
Bead Dispenser	Accessory	Accessory	Accessory	Accessory
Paint Hopper	68 lt - 18gpm	68 lt - 18gpm	68 lt - 18gpm	68 lt - 18gpm
FlipDrive Seat	Accessory	Accessory	Accessory	Accessory

ProStripe 400

Self Propelled Hydraulic Line Striper / Auto / Twin Color Pump



EXCLUSIVE

ProStripe p/n 23.9008162 + FlipDrive + Paint Hopper + Bead Hopper

ProStripe 400 Series

Hydraulic Line Striper

Industry's only 12 liter / min flow hydraulic line striper, the ProStripe 400 is equipped with a self-propelled system available also with automatic gun system & VEZOS twin slow stroke hydraulic pumps for double color line marking . Attach the FlipDrive for an easy ride and enjoy a panoramic view of the job site. 2-3 gun models, with VEZOS unique features for a revolutionary striping experience.

Features & Highlights

Unique VEZOS Features

- ◆ Foldable Chasse
- ◆ FlipDrive transformable ride system
- ◆ XXL wheel for extra stability
- ◆ Vibrated assisted bead hopper 21 lit
- ◆ Easy Wheel Alignment
- ◆ Increased visibility design
- ◆ Easy gun selector - E.G.S.
- ◆ Motorcycle Type Control / One hand motion system
- ◆ TCS - Tunnel Cooling System
- ◆ Disk lock hand brake
- ◆ Easy angle front wheel selector
- ◆ 6 ply industrial tires for long life durability



Features & Highlights

Extra Features

- ◆ Spring assisted gun holder
- ◆ Slow Stroke Hard Chromed Hydraulic Pump
- ◆ Anti-vibration system
- ◆ Low centered gravity design
- ◆ Light Kit
- ◆ Rear gun mount system
- ◆ 3 gun kit
- ◆ Automatic system
- ◆ Twin hydraulic pumps



ProStripe p/n 23.9008162 + FlipDrive + Paint Hopper + Bead Hopper

Twin Hydraulic Pump

ProStripe 400 Hydraulic

Two powerful slow stroke hydraulic pumps, working pressure 240 bar & an outstanding 12 lit/min.



Applications

ProStripe 400 Hydraulic

- ◆ City Roads
- ◆ Airports
- ◆ Parking Lots
- ◆ Intersections
- ◆ Schools / Playgrounds
- ◆ Bike Lanes
- ◆ Sport Fields

Honda Engine GX390



Materials

ProStripe 400 Hydraulic

- ◆ Common Road Marking Paint
- ◆ Heavy VOC paint
- ◆ Waterborne Paint
- ◆ Rubberized Marking Paint



Product Number	23.9008140	23.9008142
ProStripe Edition	PS 400 SP 1G	PS 400 SP 2G
ProStripe Category	Self-Propelled	Self-Propelled
Max Working Pressure	240 bar	240 bar
Max Flow	12.0 l/min	12.0 l/min
Motor Power Honda	11.7 hp net *	11.7 hp net *
* in accordance SAE J1349	13.0 gross	13.0 gross
Paint Gun - 1	1 piece	1 piece
Paint Gun - 2	Optional	1 piece
Adjustable Handle	Included	Included
Pointer 55cm	Accessory	Accessory
Bead Dispenser	Accessory	Accessory
Paint Hopper	68 lt - 18gpm	68 lt - 18gpm
FlipDrive Seat	Accessory	Accessory

ProStripe p/n 23.9008162 + FlipDrive + Paint Hopper + Bead Hopper



Product Number	23.9008150	23.9008152	23.9008160	23.9008162
ProStripe Edition	PS 400 Auto SP 1G	PS 400 Auto 2G	PS 400 SP Auto TWIN 2G	PS 400 SP Auto TWIN 3G
ProStripe Category	Auto i Self-Propelled	Auto i Self-Propelled	Auto i Self-Propelled	Auto i Self-Propelled
Max Working Pressure	240 bar	240 bar	240 bar	240 bar
Max Flow	12.0 l/min	12.0 l/min	12.0 l/min	12.0 l/min
Motor Power Honda	11.7 hp net *	11.7 hp net *	11.7 hp net *	11.7 hp net *
* in accordance SAE J1349	13.0 gross	13.0 gross	13.0 gross	13.0 gross
Auto Paint Gun - 1	1 piece	1 piece	1 piece	1 piece
Auto Paint Gun - 2	Optional	1 piece	1 piece	1 piece
Auto Paint Gun - 3	n/a	n/a	Optional	1 piece
Adjustable Handle	Included	Included	Included	Included
Pointer 55cm	Accessory	Accessory	Accessory	Accessory
Bead Dispenser	Accessory	Accessory	Accessory	Accessory
Paint Hopper	68 lt - 18gpm	68 lt - 18gpm	68 lt - 18gpm	68 lt - 18gpm
FlipDrive Seat	Accessory	Accessory	Accessory	Accessory

VEZOS

Think different. Think strong!